

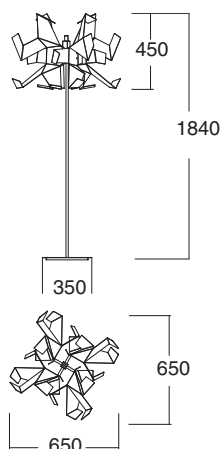

## lampade / lamps

Nome Name	Struttura Frame	Diffusore Lampshade	Codice Code
--------------	--------------------	------------------------	----------------

### GLOW TERRA / FLOOR



cromo lucido high gloss chrome	metallo verniciato bianco semilucido lacquered semigloss white metal	GLO 001-016208
antracite lacquered semigloss anthracite	alluminio naturale satinato natural satin finish aluminum	GLO 001-016209
antracite lacquered semigloss anthracite	ottone satinato e brunito burnished and satined brass	GLO 001-016210
cromo lucido high gloss chrome	metallo verniciato rosso semilucido RAL 3003 lacquered semigloss red metal RAL 3003	GLO 001-018215
cromo lucido high gloss chrome	metallo verniciato nero semilucido lacquered semigloss black metal	GLO 001-018127

 1 lampadina alogena 250 watt  
 attacco E27 cavo di  
 alimentazione e varialuce nero

 1 halogene lightbulb 250 watt fitting  
 E27 black electrical cord and dimmer

### GLOW SOSPENSIONE 1 / PENDANT 1

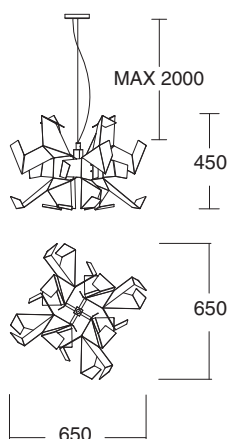

cavo in acciaio steel cable	metallo verniciato bianco semilucido lacquered semigloss white metal	GLO 011-016224
	alluminio naturale satinato natural satin finish aluminum	GLO 011-016225
	ottone satinato e brunito burnished and satined brass	GLO 011-016226
	metallo verniciato rosso semilucido RAL 3003 lacquered semigloss red metal RAL 3003	GLO 011-017693
	metallo verniciato nero semilucido lacquered semigloss black metal	GLO 011-018128

 1 lampadina alogena 250 watt attacco E27  
 lampada fornita di attacco per il posizionamento  
 al di fuori del punto luce.  
 Cavo di alimentazione trasparente

 1 halogene lightbulb 250 watt fitting E27.  
 Lamp provided with connector for  
 suspension element.  
 Transparent electrical cord

### GLOW SQUARE

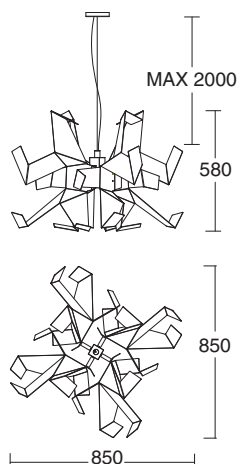

cavo in acciaio steel cable	metallo verniciato bianco semilucido lacquered semigloss white metal	GLO 015-016224
	alluminio naturale satinato natural satin finish aluminum	GLO 015-016225
	metallo verniciato rosso semilucido RAL 3003 lacquered semigloss red metal RAL 3003	GLO 015-017693
	metallo verniciato nero semilucido lacquered semigloss black metal	GLO 015-018128

 1 lampadina alogena 250 watt attacco E27  
 lampada fornita di attacco per il posizionamento  
 al di fuori del punto luce.  
 Cavo di alimentazione trasparente

 1 halogene lightbulb 250 watt fitting E27.  
 Lamp provided with connector for  
 suspension element.  
 Transparent electrical cord

## lampade / lamps

Nome Name	Struttura Frame	Diffusore Lampshade	Codice Code
--------------	--------------------	------------------------	----------------

### GLOW SOSPENSIONE 2 / PENDANT 2

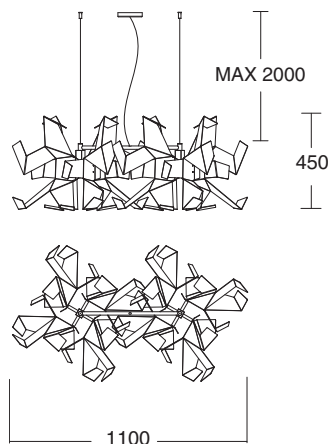

barra in acciaio cromo lucido e cavo in acciaio  
steel rod in high gloss chrome and steel cable

metallo verniciato bianco semilucido  
lacquered semigloss white metal

GLO 012-016224

alluminio naturale satinato  
natural satin finish aluminum

GLO 012-016225

ottone satinato e brunito  
burnished and satined brass

GLO 012-016226

metallo verniciato rosso semilucido RAL 3003  
lacquered semigloss red metal RAL 3003

GLO 012-017693

metallo verniciato nero semilucido  
lacquered semigloss black metal

GLO 012-018128

**CE** 2 lampadine alogene 250 watt attacco E27  
lampada fornita di attacco per il posizionamento al di fuori del punto luce. Cavo di alimentazione trasparente

■ 2 halogene lightbulbs 250 watt fitting E27.  
Lamp provided with connector for suspension element. Transparent electrical cord

### GLOW SOSPENSIONE 3 / PENDANT 3

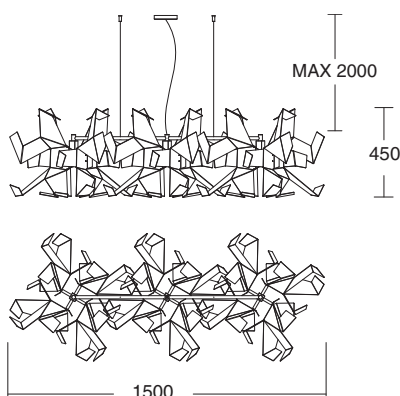

barra in acciaio cromo lucido e cavo in acciaio  
steel rod in high gloss chrome and steel cable

metallo verniciato bianco semilucido  
lacquered semigloss white metal

GLO 013-016224

alluminio naturale satinato  
natural satin finish aluminum

GLO 013-016225

ottone satinato e brunito  
burnished and satined brass

GLO 013-016226

metallo verniciato rosso semilucido RAL 3003  
lacquered semigloss red metal RAL 3003

GLO 013-017693

metallo verniciato nero semilucido  
lacquered semigloss black metal

GLO 013-018128

**CE** 3 lampadine alogene 250 watt attacco E27  
lampada fornita di attacco per il posizionamento al di fuori del punto luce. Cavo di alimentazione trasparente

■ 3 halogene lightbulbs 250 watt fitting E27.  
Lamp provided with connector for suspension element. Transparent electrical cord

### GLOW SOSPENSIONE 4 / PENDANT 4

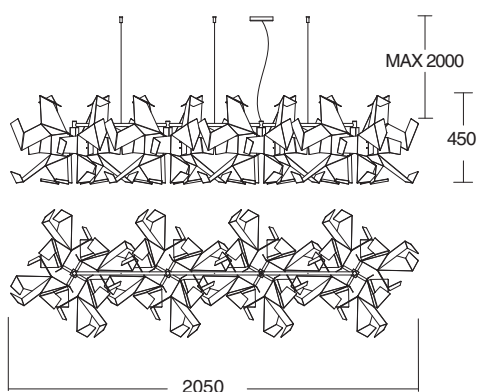

barra in acciaio cromo lucido e cavo in acciaio  
steel rod in high gloss chrome and steel cable

metallo verniciato bianco semilucido  
lacquered semigloss white metal

GLO 014-016224

alluminio naturale satinato  
natural satin finish aluminum

GLO 014-016225

ottone satinato e brunito  
burnished and satined brass

GLO 014-016226

metallo verniciato rosso semilucido RAL 3003  
lacquered semigloss red metal RAL 3003

GLO 014-017693



metallo verniciato nero semilucido  
lacquered semigloss black metal

GLO 014-018128

**CE** 4 lampadine alogene 250 watt attacco E27  
lampada fornita di attacco per il posizionamento al di fuori del punto luce. Cavo di alimentazione trasparente

■ 4 halogene lightbulbs 250 watt fitting E27.  
Lamp provided with connector for suspension element. Transparent electrical cord

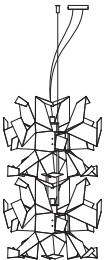
## lampade / lamps

Nome Name	Struttura Frame	Diffusore Lampshade	Codice Code
<b>GLOW SOSPENSIONE VERTICALE 2</b>			
<b>SUSPENSION VERTICAL 2</b>			
 895	barra in acciaio cromo lucido e cavo in acciaio steel rod in high gloss chrome and steel cable	metallo verniciato bianco semilucido lacquered semigloss white metal	GLO 016-016224
		alluminio naturale satinato natural satin finish aluminum	GLO 016-016225
		ottone satinato e brunito burnished and satined brass	GLO 016-016226
		metallo verniciato rosso semilucido RAL 3003 lacquered semigloss red metal RAL 3003	GLO 016-017693
		metallo verniciato nero semilucido lacquered semigloss black metal	GLO 016-018128
 650	<b>CE</b> 2 lampadine alogene 250 watt attacco E27 lampada fornita di attacco per il posizionamento al di fuori del punto luce. Cavo di alimentazione trasparente	<b>■</b> 2 halogene lightbulbs 250 watt fitting E27. Lamp provided with connector for suspension element. Trasparent electrical cord	

## GLOW SOSPENSIONE VERTICALE 3

### SUSPENSION VERTICAL 3

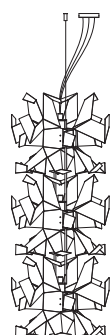

1345



650

barra in acciaio cromo lucido e cavo in acciaio steel rod in high gloss chrome and steel cable	metallo verniciato bianco semilucido lacquered semigloss white metal	GLO 017-016224
	alluminio naturale satinato natural satin finish aluminum	GLO 017-016225
	ottone satinato e brunito burnished and satined brass	GLO 017-016226
	metallo verniciato rosso semilucido RAL 3003 lacquered semigloss red metal RAL 3003	GLO 017-017693
	metallo verniciato nero semilucido lacquered semigloss black metal	GLO 017-018128
<b>CE</b> 3 lampadine alogene 250 watt attacco E27 lampada fornita di attacco per il posizionamento al di fuori del punto luce. Cavo di alimentazione trasparente	<b>■</b> 3 halogene lightbulbs 250 watt fitting E27. Lamp provided with connector for suspension element. Trasparent electrical cord	